

# DURAFIX



New Zealand

## Aluminium Soldering Rods

•Repairs Aluminium & Zinc Based Metals •Product Sales & Demonstrations •Mobile Aluminium Welding

LR & TJ Jordan  
PO Box 512  
Kaitaia 0441  
New Zealand  
+64 9 946 7575  
info@durafix.co.nz  
www.durafix.co.nz

# DURAFIX WELDING INSTRUCTIONS

Thank you for purchasing one of the most unique and best kept secrets in the Aluminium Welding Industry.

Durafix is the most widely used rod on the market for WELDING ZINC BASE metals - white - die cast - pot metals. Welds made with the rod are clean and free from slag, and produces a sound joint which is stronger than the parent metal.

As with all welding systems there are three main factors involved:

### 1. Preparation.

Preparation is the steps involved to “clean” the parent metals prior to heat being applied. The metal composition “Zinc Content” will be a large factor to consider when preparing to weld Aluminium or Zinc based items. This content will indicate the tensile strength or “how soft or hard” the alloy is? How much porosity, surface contaminants, oxides, or foreign impurities attaching themselves to the alloy is where “the pedal hits the metal”!

### 2. Heat

The type of heat recommended is generally defined by “tip size” and gas type. More pure gases such as Mapp or the introduction of Oxygen will generate more heat. Results may vary due to how the metal or items are held during the welding process, as clamps or a large steel vice can act as a “heat sink” drawing heat away from the repair area. The overall size or thickness of the item to be repaired versus the quality and quantity of the heat source can alter end results. Not all ‘Alloys’ react the same when heat is applied.

### 3. Technique

Welding Aluminium or Zinc based items with Durafix soldering rods is performed without the use of flux, produces a joint sound and free from porosity. There is no need for years of welding experience. It's convenient and can be used by both novice and professional alike. We stress that there is nothing better than to practice, practice, practice! We recommend slicing the side of a fizzy drink/aluminium beer can with a Stanley knife and start soldering up the cans. Instantly you will start “reading” how much heat you are applying and before you know it you will impress your neighbours and friends with your new found skill “repairing beer cans”!

If you have any problems with Durafix or any questions, do not hesitate to call us on 09 946 7575 or e-mail [info@durafix.co.nz](mailto:info@durafix.co.nz) We will give you personal instructions on how to use our product. Customers that call us with problems leave very satisfied and usually order again.

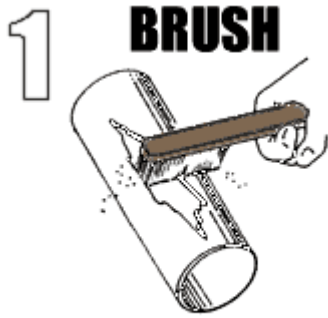

## BRUSH

### Preparation - Step I

The use of a high quality stainless steel brush is an important step in the Durafix welding process.

The pre-heating and use of a stainless steel wire brush will release or “burn off” any contaminants or coatings before welding commences. The overall hardness and purity of stainless steel allows no impurities to be left behind after brushing.

Using other cleaning processes such as:

- Steel wire brushes leave a carbon steel residue on the surface impairing the adhesion of Durafix
- Carbon “metal grinding discs” may imbed carbon residue creating welding problems. Professional Aluminium welding technicians are sometimes found using “concrete grinding discs” as this reduces carbon contamination.
- Sand Paper causes the pores of the aluminium and surface of the material to be contaminated with silicon or carbon residue therefore stopping Durafix to bond to the parent metal
- Acid washing can cause future rapid oxidation within the pores of aluminium. This process requires immediate neutralising and SS wire brushing when dry.
- Sandblasting or beadblasting can leave behind silicon or an inorganic layer creating a barrier.
- Polishing or Buffing Wheels can deposit “soaps and waxes” on the surface.

Durafix can be used to weld:

- Anodised Aluminium
- Powder Coated Aluminium
- Chromed Aluminium
- Nickel Coated Aluminium

**Provided** you remove these “coatings” in the areas to be repaired! Durafix can be anodised; however it is recommended that the welded area be nickel plated prior to anodising as the acid from the anodising process leaves a blackish scar on the joint welded with Durafix.

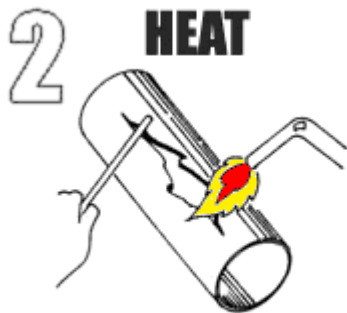

## HEAT

### Heating - Step II

**Welding, Soldering or Brazing Aluminium is now as easy as 1-2-3. There is no need for expensive equipment and specialist gases. This rod will work with Propane, MAPP, Butane, oxyacetylene or any fuel source as long as the material is brought up to 389°C (732°F).**

When using Durafix Soldering Rods we recommend the technician to:

- Use a slightly carbonised flame (excess of acetylene), with small tip for most work.
- Heat the material that you are working on to 389°C (732°F) and then apply the rod.
- Rub the weld area with rod and re-brush thus causing a tinning process
- Keep the heat off the rod as it will not work if heated directly.
- Refrain from using excess heat, as this will cause Aluminium to “boil” and become brittle

# 3 RUB - IN

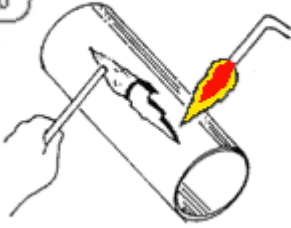

## Repairing - Step III

You must heat the material that you are working on to 389°C (732°F) and then apply the rod. Keep the heat off the rod...rub the rod on the heated surface & treat it like a true solder not like gas or stick welding.

- Do not use Durafix on Magnesium. (To test for Magnesium shave a small piece of metal and apply the flame. If it burns white, then it is Magnesium).
- Do not use on Pewter or tin as they will melt before the working temperature is reached.
- Durafix can be used to bond galvanised sheet steel as it will bond to the zinc

### HOW TO WELD ZINC BASED METALS WITH DURAFIX ROD

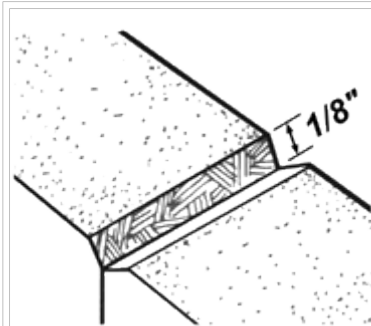

Vee the broken edges to about 45 degrees, clean the surface of any plating or scale back from edges of the vee 1/8 of an inch.

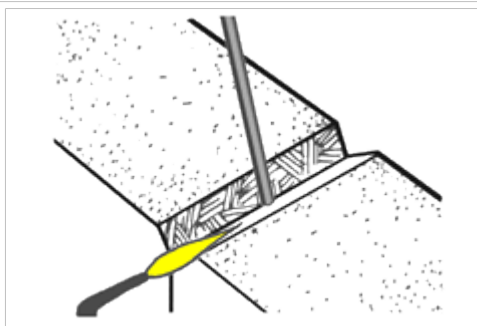

Heat until it starts to flow. Turn flame parallel to surface and with side of flame, hold at this heat. Heat welding rod to same temperature. Now with both bases and welding rod at this temperature, touch rod to the break and rod will flow into vee, thoroughly fusing the parts.

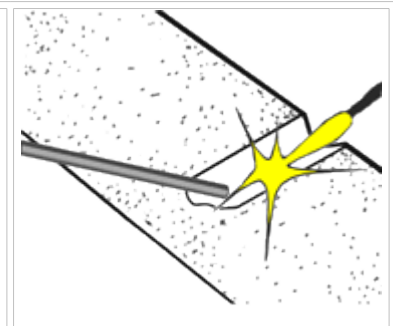

Repeat operation until break is completely filled. Be sure to kick rod into weld to break down skin resistance as filler rod will lay on surface and will not fuse if only heat is applied.

### HOW TO BRAZE ALUMINUM WITH DURAFIX ROD



Brush surface to be repaired thoroughly under heat to break up surface oxide.

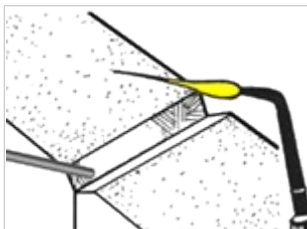

Heat the parts hot enough to flow without the aid of the flame, thoroughly tinning the surface.

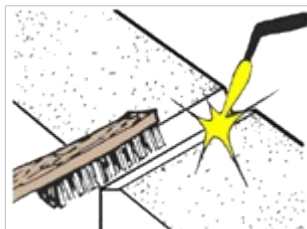

Brush Tinned surface under heat, thoroughly filling the open pores.

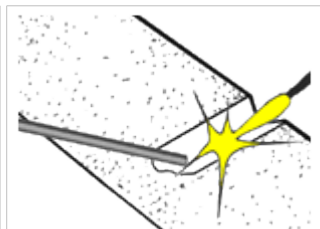

With sides thoroughly tinned, flow in enough rod to fill the Vee. Be sure filler fuses with the tinned surface without melting the base metal.

# The Heat process

## Process features

Oxyacetylene welding, commonly referred to as gas welding, is a process which relies on combustion of oxygen and acetylene. When mixed together in correct proportions within a hand-held torch or blowpipe, a relatively hot flame is produced with a temperature of about 3,200°C. The chemical action of the oxyacetylene flame can be adjusted by changing the ratio of the volume of oxygen to acetylene. Aluminium has a boiling point of 2519 °C (4566 °F).

Three distinct flame settings are used, neutral, oxidising and carburising.



Neutral flame



Oxidising flame



Carburising flame

Welding Durafix is generally carried out using the carburising flame setting which is achieved by increasing acetylene flow in relation to oxygen flow. The carburising flame is utilised because Aluminium melts at a low temperature of 660°C (1220.58°F). Durafix has a melting point of 388.9°C (732°F). Oxyacetylene is used as it is the only gas combination with enough heat to weld large surface areas or items. However, other gases such as propane, MAPP, LPG can be used for joining medium to small items made of zinc based or non-ferrous metals, and for brazing and silver soldering. The mixing of pure oxygen with LPG, MAPP or propane produces a heat range similar but slightly less to that of oxyacetylene.

## Types of Weld Joints

- Butt, T, corner, lap, and T joints are the common types of joints used in Aluminium welding. These can all be used in the Durafix Welding System.
- Corner joints are used frequently in sheet metal cabinet construction.

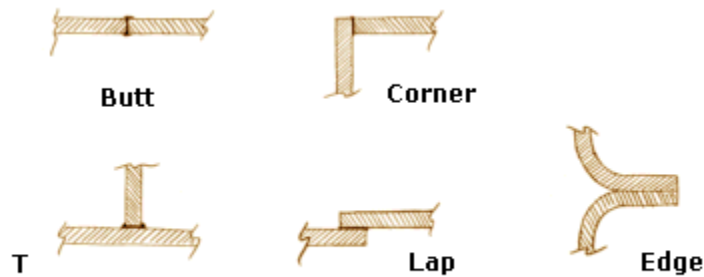

TYPES OF WELD JOINTS

- Types of welds are often confused with the types of joints. The basic types of welds are fillet, square, and grooved. V-grooved welding is often utilised for repairs in the Durafix Welding System.



TYPES OF WELDS

## Our Commitment to You

We want to make sure that you are happy with the products we send you and with the service we give. Please let us know if we can help you in any way by phoning 09 4280620. Your rights as a consumer are protected under the Consumer Guarantees Act, and backed up by our promise to give you quality products and good service. If we deliver a faulty or defective item or it arrives damaged, we will replace it for you without cost. All our merchandise products are guaranteed against faulty materials and workmanship for one year from the date of delivery. Faulty items will be repaired or replaced at the discretion of Durafix NZ and or our manufacturers.

## Testimonials

We are very interested in the types of repairs you have carried out and the results. Please forward any comments or your stories of success to [info@durafix.co.nz](mailto:info@durafix.co.nz).